

SPECIFICATION FOR APPROVAL

PRODUCT	12Vdc 5000mA SPS
MODEL	SW60-12005000-W
PART NO.	SW60-12005000-WE5
VER:	A
CUSTOMER	PWK
DATE	2015.4.21

本 电 器 符 合	MEETSAFETYSTD., MEET ROHS MEET CEC STD.
AC PIN:	3

希望回签日/EXPECTED FEEDBACK BEFORE: 2015年05月20日

发行印

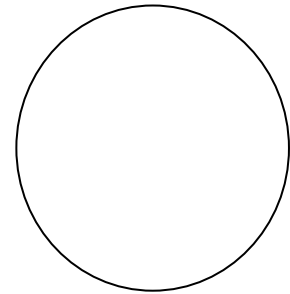

*未签回而下订单即视同认可!

生产工厂 /MANUFACTORY	设计验证/日期 DESIGN VERIFIED BY	设计师/日期 DESIGNED BY	工程确认/日期 Engineering Verification BY	QE 验证/日期 QE VERIFIED BY
TAE				

SHENZHEN TOP-ASIA ELECTRONICS CO. LTD.

地址: 深圳市宝安区西乡后瑞新瑞物流园 B 栋三楼

Add: 3F//A&B .XinRui Logistics pack, HouRui, HuangTian, Xixiang Town
, Baoan, Shenzhen, P. R. C.

业务联系: 채선국 (CAI SEON GUK) 070-8860-1863

E-mail: hdt7451@hanmail.net

Tel : 070-8860-1863

P. C: 518108

Fax: 031-769-1863

PRODUCT SPECIFICATIONS

Index

1. Scope	4
2. Electrical Characteristics test	4
2.1 Input Characteristic	4
2.1.1 Input Voltage and Frequency	4
2.1.2 Input current	4
2.1.3 Ac inrush current	4
2.1.4 Input leakage current	4
2.1.5 Efficiency	4
2.1.6 Stand-by power consumption	4
2.2 Output Characteristic.....	5
2.2.1 Output voltage and current	5
2.2.2 Startup and Turn-on Delay	5
2.2.3 Overshoot	5
2.2.4 Short-Circuit Protection (SCP)	5
2.2.5 Over Current Protection (OCP)	5
2.2.6 Over Voltage Protection (OVP)	5
3. EMC-Specification	6
4. Safety details:	6
5. Mechanical Specifications	6
5.1 Physical	6
5.2 Input and Output Configuration	6
附页	
6. DC Cord.....	1
7. Production of appearance drawing	1
8. Label	1
9. PE BAG.....	1
10. Packing.....	2

PRODUCT SPECIFICATIONS

1 Scope:

This document describes power supply unit for the I.T.E.. This document covers all electrical, mechanical, environmental and testing aspects of the power supply unit. The power supply unit must comply with all of the requirements of this specification and the drawings and specifications referenced here in.

2 Electrical Characteristic test:

2.1 Input Characteristics:

2.1.1 Input Voltage and Frequency

The power supply shall meet all specifications when powered from the following sources.

Voltage Range	Line Frequency	Minimum Voltage	Maximum Voltage
100-240Vac	47 ~ 63 Hz	90Vac	264 Vac

2.1.2 Input Current

The maximum input current shall be less than 1.5A.

2.1.3 AC Inrush Current

At Full Load,25°C,Cold Start

115VAC,60Hz INPUT	NO damage shall be occurred and the input fuse shall not be blown up
230VAC,50Hz INPUT	

2.1.4 Input Leakage Current

The leakage current shall not exceed 3.5 mA.

2.1.5 Efficiency

80.0% Minimum. At input 100-240Vac,100%Load.

2.1.6 Stand-by power consumption

0.50W Max At AC nominal input@output min load

PRODUCT SPECIFICATIONS

2.2 Output Characteristics:

2.2.1 Output Voltage and Current

The power supply shall have one regulated DC output of +12V.

The table below defines the total regulation band for the output, which includes line regulation, load regulation, transient response, and effects due to environmental conditions and aging. Voltage shall be measured at the power supply output connector

Mode	Output Current Range		Output Voltage range		Ripple Noise
	Min.	Max.	Min.	Max.	Max.
C.C.	0mA	5000mA	11.4V	12.6V	120mVpp

Ripple & Noise Test: Add 0.1uF/50V ceramic capacitor and 10uF/50V capacitor across the output terminal. Measured with 20MHz Bandwidth Oscilloscope.

Line regulation: <1%, Load regulation: <5%

2.2.2 Startup and Turn-on Delay

Power supply shall be able to start up into a resistive load up to the maximum rated current with maximum load capacitance of 1,000uF. The elapsed time between the application of input power and the attainment of output voltage to the nominal value shall not exceed 3 second.

2.2.3 Overshoot

At turn on, the output voltage shall not exceed steady state by more than 10%.

2.2.4 Short-Circuit Protection

The Adapter is protected that a short happened between the output terminals and shall not result in a fire hazard ,and will be normal operation automatically while the short is removed

2.2.5 Over Current Protection

No safety hazard

2.2.6 Over Voltage Protection

No safety hazard

Customer:
Model: SW60-12005000-W
SPECIFICATION NO.:
Part no.: SW60-12005000-WE5

Switching Mode Power Supply

PRODUCT SPECIFICATIONS

3 EMC-Specification

Noise-suppressed acc: EN 55022

4 Safety details:

Standards/class	:	EN60950	Class I
Voltage rating	input :	100Vac-240Vac	50/60Hz
	Output :	12.0Vdc	5.0A
High-voltage test	:	≥ 1.8KV/2S	
Leakage current	:	Maximum leakage current is 10mA	
Application range	:	Information technology equipment Including electrical business equipment	
Ambient temperature	:	0°C to +40°C , 10 to 90% rhd	

5 Mechanical Specifications

5.1 Physical

Case material: PC
Dimensions: 120mm(L) x 53mm(W) x 35mm(H)

5.2 Input and Output Configuration

Input Pin: IEC 3 pins
Output Connector: 2.5*5.5*10mm "H" type 音叉带沟槽
Polarity: Center positive
Cord: 1.5m AWM1185 18AWG

Customer:
Model: SW60-12005000-W
SPECIFICATION NO.:
Part no.: SW60-12005000-WE5

Switching Mode Power Supply

PRODUCT SPECIFICATIONS

6 DC/AC Cord drawing (black) :

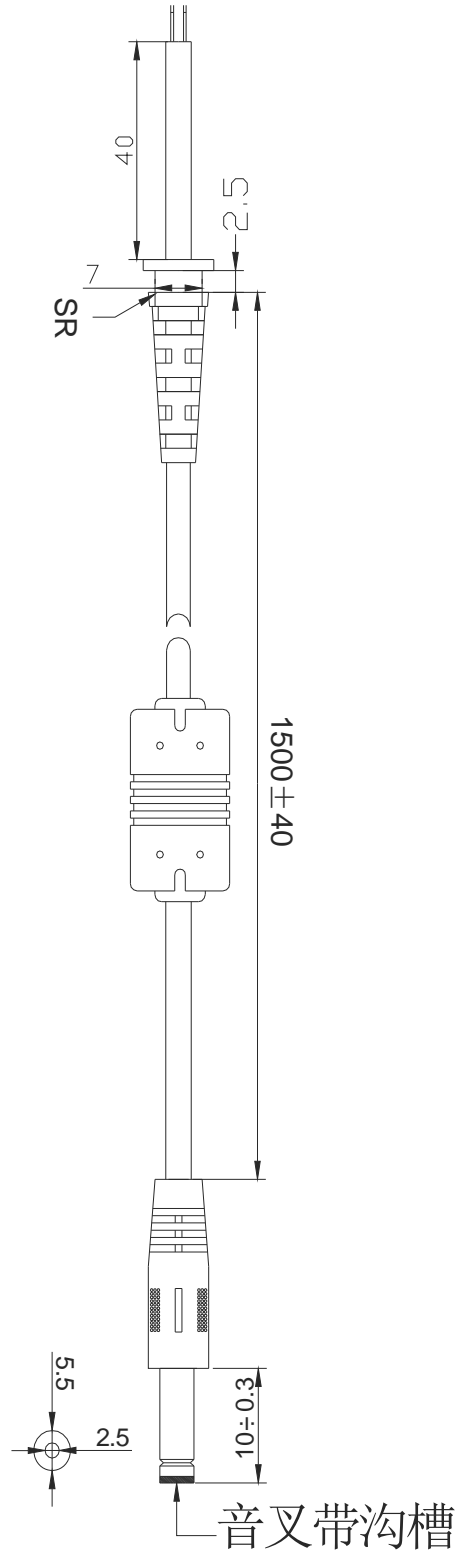

WIRE:AWM1185 18AWG

DC PLUG: $\Phi 5.5 \times 2.5 \times 10\text{mm}$

COLOR:BLACK

Customer:
Model: SW60-12005000-W
SPECIFICATION NO.:
Part no.: SW60-12005000-WE5

Switching Mode Power Supply

PRODUCT SPECIFICATIONS

7 Production of appearance drawing(black):

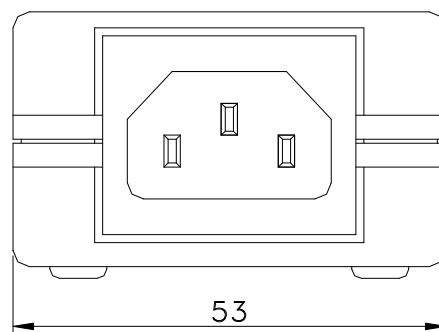
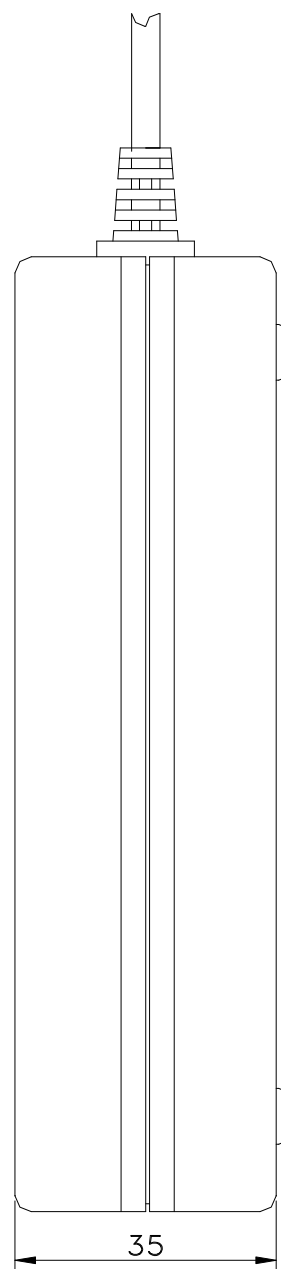
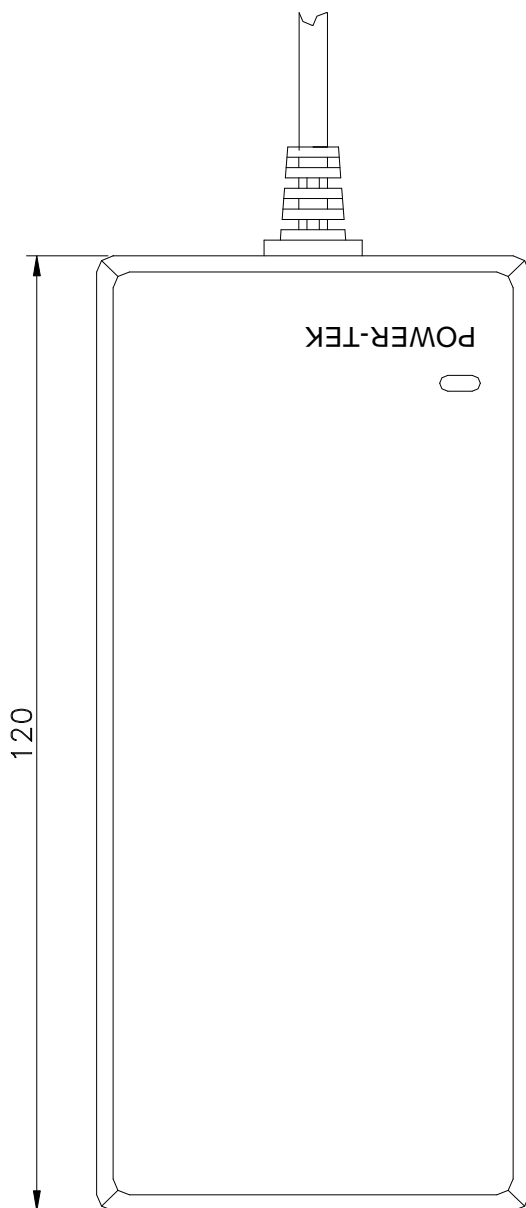

Customer:
 Model: SW60-12005000-W
 SPECIFICATION NO.:
 Part no.: SW60-12005000-WE5

Switching Mode Power Supply

PRODUCT SPECIFICATIONS

8 Label:

$39.8^{+0}_{-0.2}$



电源适配器
AC/DC ADAPTER

MODEL/型号: SW60-12005000-W
 PART/料号: SW60-12005000-WE5
 INPUT/输入: 100-240V~50/60Hz, 1.5A
 OUTPUT/输出: 12V --- 5.0A

직류전원장치
 모델명 :SW60-12005000-W
 정격입력 :100-240V~50/60Hz 1.5A
 정격출력 : 12V --- 5.0A

⊖ — ⊕

제 조 자: SHENZHEN TOP-ASIA ELECTRONICS CO.,LTD
 HONGKONG POWER-TEK INTERNATIONAL CO.,LTD

제 조 국 : CHINA
 A/S연락처: 판매처 문의
 전기용품안전관리법에 의한 표시



HU10553-14019
A/S 센터:



届出事業者



www.tuv.com
ID 1000000000



garantie Sicherheit



A072221











LISTED
E333054
46AV
I.T.E. POWER SUPPLY

CAUTION 注意:
 FOR INDOOR USE ONLY
 仅限室内使用

RISK OF ELECTRIC SHOCK
 内有高压危险

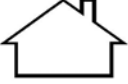
DRY LOCATION USE ONLY
 仅限在干燥地点使用

최저소비효율기준 만족 제품
MADE IN CHINA 中国制造

备注:

铭牌颜色: 灰底黑字

Customer:
Model: SW60-12005000-W
SPECIFICATION NO.:
Part no.: SW60-12005000-WE5

Switching Mode Power Supply

PRODUCT SPECIFICATIONS

9 PE BAG:

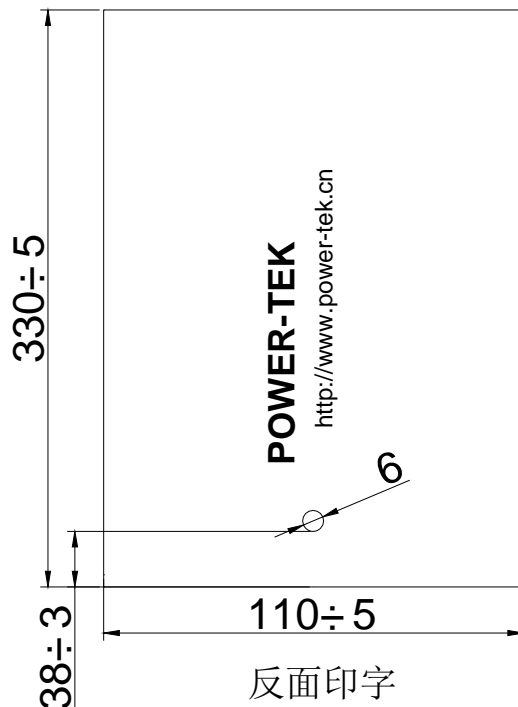
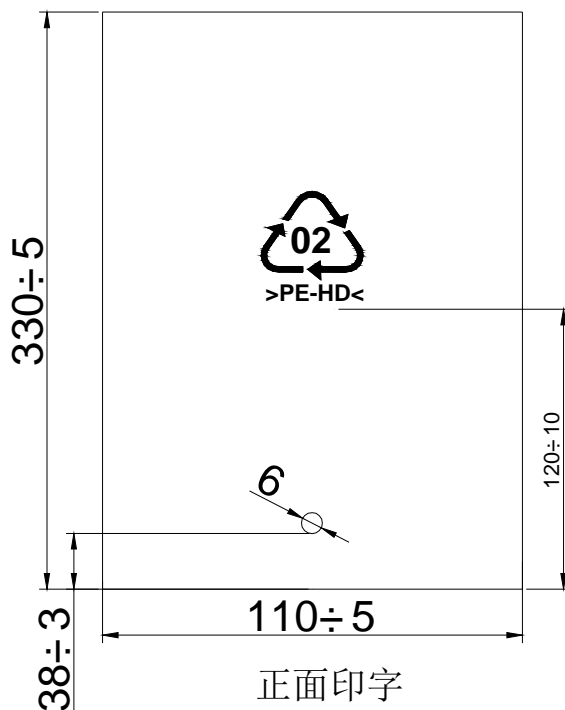

NOTE:

1. 材质: PE材质
2. 厚度: 0.06mm
3. 颜色: 透明
4. 印字颜色: 黑色

Customer:
 Model: SW60-12005000-W
 SPECIFICATION NO.:
 Part no.: SW60-12005000-WE5

PRODUCT SPECIFICATIONS

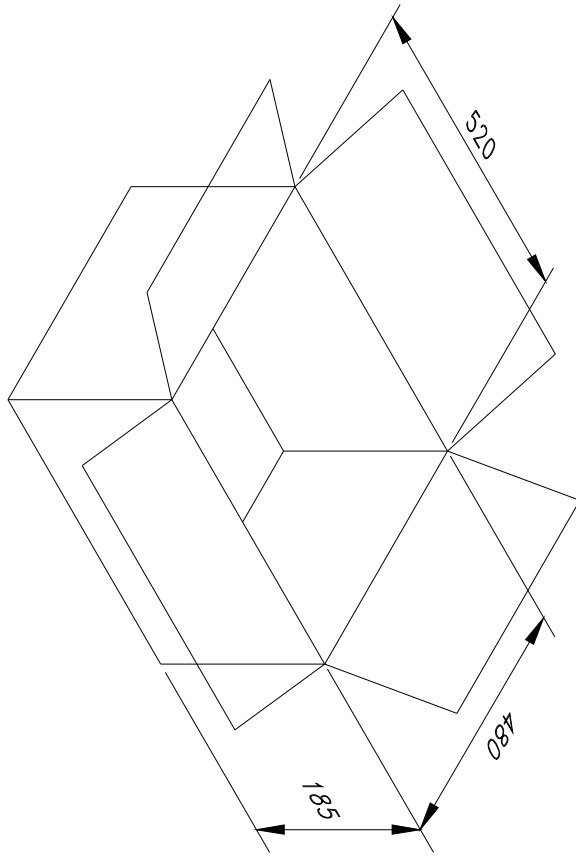

备注:

1. 纸箱材质为K=K
2. 外箱尺寸为外部尺寸，公差为：+5,-0.
3. 装箱方式：50PCS/箱

深圳市齐亚圣电子有限公司		设计	审核	核准	单位	mm
使用机种	料号	品名	规格	尺寸	A4	日期
	外箱			版本	A	

Customer:
 Model: SW60-12005000-W
 SPECIFICATION NO.:
 Part no.: SW60-12005000-WE5

PRODUCT SPECIFICATIONS

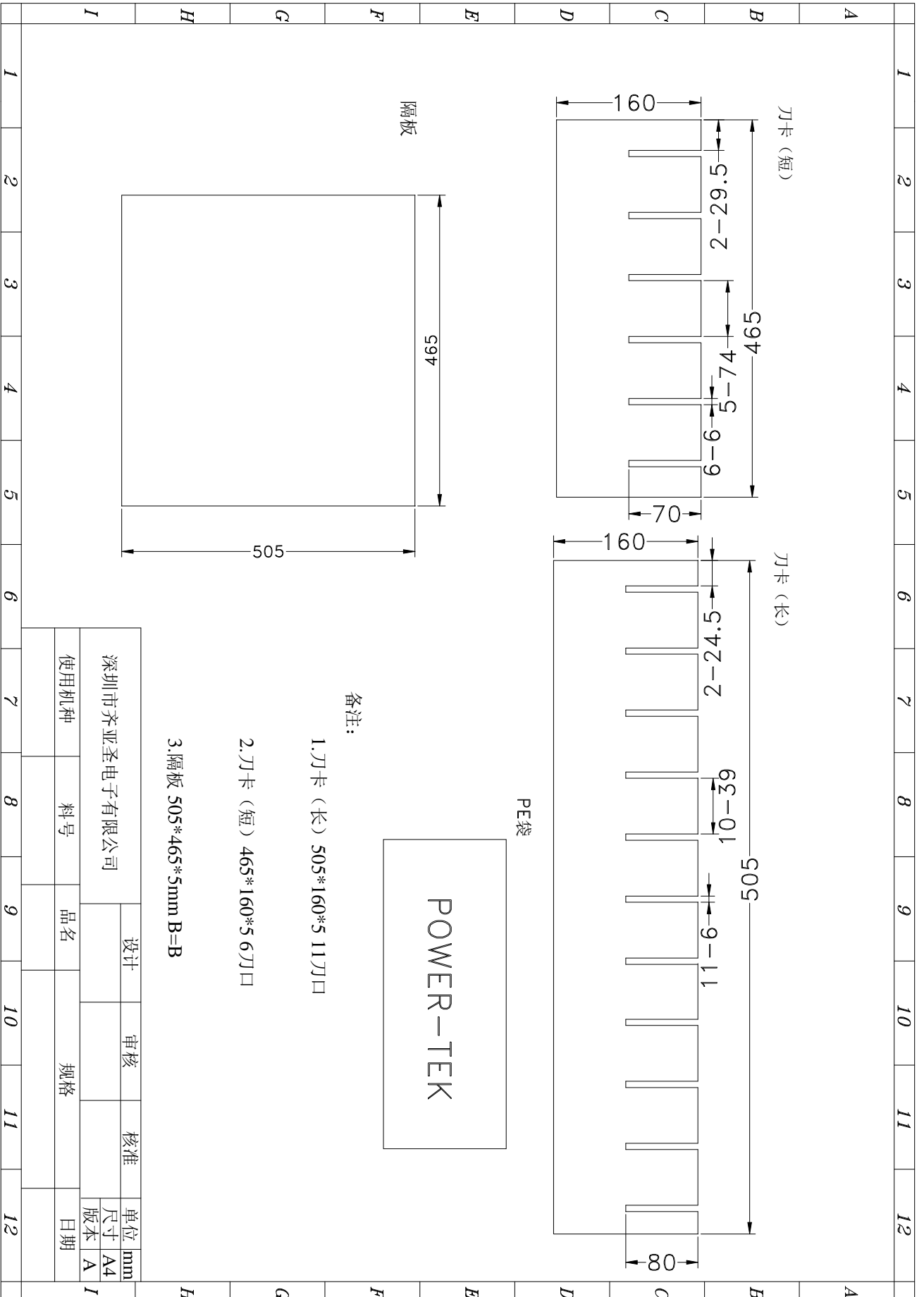

备注:

1.刀片 (长) 505*160*5 11刀口

2.刀片 (短) 465*160*5 6刀口

3.隔板 505*465*5mm B=B

Customer:
Model: SW60-12005000-W
SPECIFICATION NO.:
Part no.: SW60-12005000-WE5

Switching Mode Power Supply

PRODUCT SPECIFICATIONS

適合証明書 Certificate of Conformity



証明書番号 Certificate No. ページ Page
JD 50236042 1

申請者照会番号 Applicant Reference 検査機関照会番号 Our Reference 発行年月日 Date of Issue
143224480 01-NGS-16044282 001 2012年09月03日

申請者 Applicant
ShenZhen Top-Asia Electronics Co., Ltd.
3F//B XinRui Logistics Pack HouRui HuangTian
Bao'an Shenzhen Guangdong, 518102, P.R. China

製造工場 Factory
ShenZhen Top-Asia Electronics Co., Ltd.
3F//B XinRui Logistics Pack HouRui HuangTian
Bao'an Shenzhen Guangdong, 518102, P.R. China



検査の方法 Inspection Method

- ・ 技術基準 省令第2項: J60950-1(H22), J55022(H22), J3000(H21)
Technical Requirements Clause 2: J60950-1(H22), J55022(H22), J3000(H21)
- ・ 施行規則別表第四 (交流用電気機械器具)
Appendix 4 of the Enforcement Regulations (AC Electric Appliances)

特定電気用品名 : 直流電源装置
Name of Specified Electrical DC Power Supply Unit
Appliance and Material

型式の区分 : (「添付 1.0, 1.1」参照)
Type Classification (Refer to "Attachment 1.0, 1.1")

海外製造事業者 : ShenZhen Top-Asia Electronics Co., Ltd.
Overseas Manufacturer 3F//B XinRui Logistics Pack HouRui HuangTian Bao'an Shenzhen Guangdong,
518102, P.R. China

客先名 : HongKong Power-tek International Co., Limited
Client ROOM 1708A1 NAN FUNG TOWER, 173 DES VOEUX ROAD C., HONG KONG

証明書の有効期間 : 本証明書は、施行令で規定された期間である2017年09月02日まで有効です。
Validity of Certificate This certificate is effective until 02 September 2017, being the period stipulized by the Enforcement Ordinance.

これは、上記申請者より申請のあった上記特定電気用品及び製造工場が、電気用品安全法第八条第一項に規定する技術基準及び同法第九条第二項の経済産業省令で定める基準に適合していることを証明するものです。

This is to certify that the above-mentioned Specified Electrical Appliances and Materials and the factory which the above-mentioned applicant applied for have been complied with the Technical Requirements stipulated by Article 8, Paragraph 1 of the Electrical Appliance and Material Safety Law and the requirements stipulated by the METI Ordinance specified in Article 9, Paragraph 2 of the said law.

テュフ ラインランド 香港 リミテッド
TÜV Rheinland Hong Kong Ltd.

ゴールドフィナンシャルグローバルスクエア8-10F,
7ワンダイロード, クロンベイ, クロン, 香港
8-10 Floor, Golden Financial Global Square,
7 Wang Tai Road, Kowloon Bay,
Kowloon, Hong Kong



発行者 Issued by

IC & Name Ma Wen Wong

Customer:
 Model: SW60-12005000-W
 SPECIFICATION NO.:
 Part no.: SW60-12005000-WE5

Switching Mode Power Supply

PRODUCT SPECIFICATIONS



添付 Attachment : 1.0 発行日 Date of Issue : 2012 年 09 月 03 日

【型式の区分 Type Classification】

型式区分管理 No: (Type Classification Control No.) : CL-01

証明書番号 (Certificate No.) : JD 50236042

特定電気用品名 (Name of Specified Electrical Appliance and Material) : 直流電源装置
DC Power Supply Unit

申請者 (Applicant) : ShenZhen Top-Asia Electronics Co., Ltd.

海外製造事業者 (Overseas Manufacturer/factory) : ShenZhen Top-Asia Electronics Co., Ltd.

客先名 (Client) : HongKong Power-tek International Co., Limited

要素 Factor	区分 Classification
定格入力電圧 (Rated input voltage)	125V 以下のもの 及び 125V を超えるもの (125V or less, and Exceeding 125V)
入力側の定格容量 (Rated capacity on input side)	100VA を超え 200VA 以下のもの (Exceeding 100VA, and less than or equal to 200VA)
定格周波数 (変圧器を有するものの場合に限る。) (Rated frequency (limited to those with transformer))	50Hz のもの 及び 60Hz のもの (50Hz and 60Hz)
交流用端子 (AC terminal)	ないもの (Without AC terminal)
直流定格電圧 (Rated DC voltage)	15V 以下のもの (15V or less)
変圧器 (Transformer)	あるもの (With transformer)
変圧器の巻線の絶縁の種類 (Transformer winding insulation class)	B 種のもの (Class B)
直流電圧の調整装置 (DC voltage adjusting mechanism)	ないもの (Without adjusting mechanism)
回路の保護機構 (Circuit protection device)	あるもの (With circuit protection device)
器体スイッチ (Body switch)	ないもの (Without body switch)
外郭の材料 (Outer case material)	合成樹脂のもの (Plastic)
用途 (Application)	その他のもの (Other)
電源電線と器体との接続の方式 (Method of attaching power supply cord)	接続器利用のもの (Coupling Device)
二重絶縁 (Double insulation)	施していないもの (Without double insulation)

テュフ ラインランド 香港 リミテッド
 TÜV Rheinland Hong Kong Ltd.
 ゴールドフィンランシヤルグロブアルスクエア8-10F,
 7ワンタイロード、クワンバイ、クワン、香港
 8-10 Floor, Golden Financial Global Square,
 7 Wang Tai Road, Kowloon Bay,
 Kowloon, Hong Kong

発行者 Issued by



(Signature)

氏名 Name Marvin Wang

Customer:
 Model: SW60-12005000-W
 SPECIFICATION NO.:
 Part no.: SW60-12005000-WE5

Switching Mode Power Supply

PRODUCT SPECIFICATIONS

添付 Attachment : 1.1

発行日 Date of issue : 2012 年 09 月 03 日

【型式の区分 Type Classification】

型式区分管理 NO: (Type Classification Control No.) : CL-01

証明書番号 (Certificate No.) : JD 50236042

特定電気用品名 (Name of Specified Electrical Appliance and Material) : 直流電源装置
 DC Power Supply Unit

申請者 (Applicant) : ShenZhen Top-Asia Electronics Co., Ltd.

海外製造事業者 (Overseas Manufacturer/factory) : ShenZhen Top-Asia Electronics Co., Ltd.

客先名 (Client) : HongKong Power-tek International Co., Limited



要素 Factor	区分 Classification
定格入力電圧 (Rated input voltage)	125V 以下のもの 及び 125V を超えるもの (125V or less, and Exceeding 125V)
入力側の定格容量 (Rated capacity on input side)	100VA を超え 200VA 以下のもの (Exceeding 100VA, and less than or equal to 200VA)
定格周波数 (変圧器を有するものの場合に限る。) (Rated frequency (limited to those with transformer))	50Hz のもの 及び 60Hz のもの (50Hz and 60Hz)
交流用端子 (AC terminal)	ないもの (Without AC terminal)
直流定格電圧 (Rated DC voltage)	15V を超え 30V 以下のもの (Exceeding 15V and less than or equal to 30V)
変圧器 (Transformer)	あるもの (With transformer)
変圧器の巻線の絶縁の種類 (Transformer winding insulation class)	B 種のもの (Class B)
直流電圧の調整装置 (DC voltage adjusting mechanism)	ないもの (Without adjusting mechanism)
回路の保護機構 (Circuit protection device)	あるもの (With circuit protection device)
器体スイッチ (Body switch)	ないもの (Without body switch)
外郭の材料 (Outer case material)	合成樹脂のもの (Plastic)
用途 (Application)	その他のもの (Other)
電源電線と器体との接続の方式 (Method of attaching power supply cord)	接続器利用のもの (Coupling Device)
二重絶縁 (Double insulation)	施していないもの (Without double insulation)

デュフ ラインランド 香港 リミテッド
 TÜV Rheinland Hong Kong Ltd.

ゴールドフィンランシヤルグローバルスクエア8-10F,
 7ワンタイロード, クロンベイ, クロン, 香港
 8-10 Floor, Golden Financial Global Square,
 7 Wang Tai Road, Kowloon Bay,
 Kowloon, Hong Kong

発行者 Issued by



氏名 Name: Marvin Yikng

Customer:
Model: SW60-12005000-W
SPECIFICATION NO.:
Part no.: SW60-12005000-WE5

Switching Mode Power Supply

PRODUCT SPECIFICATIONS



中国国家强制性产品认证证书

证书编号: 2010010907427589

委托人名称、地址

香港通用电源国际有限公司
香港德辅道中173号南丰大厦1708A1室

生产者(制造商)名称、地址

深圳市齐亚圣电子有限公司
深圳市宝安区西乡街道后瑞社区新瑞路新瑞工业园B栋第三层北侧部分B区

生产企业名称、地址

深圳市齐亚圣电子有限公司
深圳市宝安区西乡街道后瑞社区新瑞路新瑞工业园B栋第三层北侧部分B区

产品名称和系列、规格、型号

电源适配器

SW_p-xy-W, SW_p-xy-Z (p=24-60 表示不同的客户需求; x=1200-2400 表示输出电压 12-24VDC; y=1000-5000 表示输出电流1.0-5.0A) 输入:100-240Vac, 50-60Hz, 1.5A
具体型号规格见附件, 仅适用于海拔2000米及以下, 仅适用于非热带气候条件

产品标准和技术要求

GB9254-2008; GB4943.1-2011; GB17625.1-2012

上述产品符合强制性产品认证实施规则
CNCA-01C-020: 2010的要求, 特发此证。

发证日期: 2013年07月26日 有效期至: 2015年08月27日

证书有效期内本证书的有效性依据发证机构的定期监督获得保持。

本证书为变更证书, 证书首次颁发日期: 2010年08月27日

本证书的相关信息可通过国家认监委网站www.cnca.gov.cn查询



主任:

中国质量认证中心

中国·北京·南四环西路188号9区 100070

<http://www.cqc.com.cn>



Q 0769675

Customer:
Model: SW60-12005000-W
SPECIFICATION NO.:
Part no.: SW60-12005000-WE5

Switching Mode Power Supply

PRODUCT SPECIFICATIONS



CERTIFICATE FOR CHINA COMPULSORY PRODUCT CERTIFICATION

No. : 2010010907427589

NAME AND ADDRESS OF THE APPLICANT

Hong Kong Power-TEK International Co., Limited
ROOM 1708A1 NANFUNG TOWER, 173 DES VOEUX ROAD C., HONGKONG

NAME AND ADDRESS OF THE MANUFACTURER

Shenzhen Top-Asia Electronics Co., Ltd
3F/B XinRui Logistics Park HouRui Huang'Tian Bao'an Shenzhen

NAME AND ADDRESS OF THE FACTORY

Shenzhen Top-Asia Electronics Co., Ltd
3F/B XinRui Logistics Park HouRui Huang'Tian Bao'an Shenzhen

NAME, MODEL AND SPECIFICATION

ADAPTER

SWp-xy-W, SWp-xy-Z (p=24-60 表示不同的客户需求; x=1200-2400 表示输出电压 12-24VDC; y=1000-5000 表示输出电流1.0-5.0A) 输入:100-240Vac, 50-60Hz, 1.5A
具体型号规格见附件, 仅适用于海拔2000米及以下, 仅适用于非热带气候条件

THE STANDARDS AND TECHNICAL REQUIREMENTS FOR THE PRODUCTS

GB9254-2008; GB4943.1-2011; GB17625.1-2012

This is to certify that the above mentioned products have met the requirements of implementation rules for compulsory certification (REF NO. CNCA-01C-020:2010).

Date of issue: Jul. 26, 2013 Date of expiry: Aug. 27, 2015

Validity of this certificate is subject to positive result of the regular follow up inspection by issuing certification body until the expiry date.

Date of original certification: Aug. 27, 2010

This certificate can be verified through CNCA's website: www.cnca.gov.cn



President:

Wang Kejiao

CHINA QUALITY CERTIFICATION CENTRE

Section 9, No. 188, Nansihuan Xilu, Beijing 100070 P.R. China

<http://www.cqc.com.cn>



Customer:
 Model: SW60-12005000-W
 SPECIFICATION NO.:
 Part no.: SW60-12005000-WE5

Switching Mode Power Supply

PRODUCT SPECIFICATIONS



中国国家强制性产品认证证书

附录:

第 1 页 共 2 页

证书编号: 2010010907427589

纸号: 257477

表 1

型号	输出电压 (V)	输出电流 (A)	输出功率 (W)
SWp-12002000-W	12	2.0	24.0
SWp-12002500-W	12	2.5	30.0
SWp-12003000-W	12	3.0	36.0
SWp-12003500-W	12	3.5	42.0
SWp-12004000-W	12	4.0	48.0
SWp-12004500-W	12	4.5	54.0
SWp-12005000-W	12	5.0	60.0
SWp-14001800-W	14	1.8	25.2
SWp-14002000-W	14	2.0	28.0
SWp-14002500-W	14	2.5	35.0
SWp-14003000-W	14	3.2	44.8
SWp-14003500-W	14	3.5	49.0
SWp-14004000-W	14	4.0	56.0
SWp-15002000-W	15	2.0	30.0
SWp-15002500-W	15	2.5	37.5
SWp-15003000-W	15	3.0	45.0
SWp-15003500-W	15	3.5	52.5
SWp-15004000-W	15	4.0	60.0
SWp-18001500-W	18	1.5	27.0
SWp-18002000-W	18	2.0	36.0
SWp-18002500-W	18	2.5	45.0
SWp-18003000-W	18	3.0	54.0
SWp-18003500-W	18	3.5	63.0
SWp-19001500-W	19	1.5	28.5
SWp-19002000-W	19	2.0	38.0
SWp-19002500-W	19	2.5	47.5
SWp-19003160-W	19	3.16	60.0

注: 此附录与证书同时使用时有效。



主任:

中国质量认证中心

中国·北京·南四环西路 188 号 9 区 100070

<http://www.cqc.com.cn>



Customer:
 Model: SW60-12005000-W
 SPECIFICATION NO.:
 Part no.: SW60-12005000-WE5

Switching Mode Power Supply

PRODUCT SPECIFICATIONS



中国国家强制性产品认证证书

附录:

第 2 页 共 2 页

证书编号: 2010010907427589

纸号: 257477

SWp-20001500-W	SWp-20001500-Z	20	1.5	30.0
SWp-20002000-W	SWp-20002000-Z	20	2.0	40.0
SWp-20002500-W	SWp-20002500-Z	20	2.5	50.0
SWp-20003000-W	SWp-20003000-Z	20	3.0	60.0
SWp-24001000-W	SWp-24001000-Z	24	1.0	24.0
SWp-24001500-W	SWp-24001500-Z	24	1.5	36.0
SWp-24002000-W	SWp-24002000-Z	24	2.0	48.0
SWp-24002500-W	SWp-24002500-Z	24	2.5	60.0

注: 此附录与证书同时使用时有效。



主任:

中国质量认证中心

中国·北京·南四环西路 188 号 9 区 100070

<http://www.cqc.com.cn>



Customer:
 Model: SW60-12005000-W
 SPECIFICATION NO.:
 Part no.: SW60-12005000-WE5

Switching Mode Power Supply

PRODUCT SPECIFICATIONS

전기용품안전 관리법 시행규칙 [별지 제2호서식]



접수번호 : 20140814 - 0050

전기용품안전인증서 Electrical Appliances Safety Certificate

안전인증번호: HU10553-14019A
 (Certificate No.)
제조업자명: Shenzhen Top-Asia Electronics Co., Limited.
 (Manufacturer)
대표자명: DAOL WONG
 (President)
제조공장의 주소: 3F/B, XinRui Logistics Park HouRui Village, HuangTian, Bao'an,
 (Factory Address) Shenzhen city, Guangdong, China.
제품명: 직류전원장치 (AC/DC Adapter)
 (Product)
기본모델명: SW60-24002500-W
 (Basic Model)
정격: 100-240 V~, 50/60 Hz, 1.5 A (O/P: 24 Vdc, 2.5 A)
 (Rating)
파생모델명 (Series Model):
 SW26-12502000-W SW30-12002500-W
 SW30-13502000-W SW30-14002000-W
 SW30-14402000-W SW30-15002000-W
 SW32-12502500-W SW32-12602500-W
 SW35-14002500-W SW36-12003000-W
 SW36-13502500-W SW36-14402500-W
 SW36-16802000-W SW36-18002000-W
 SW36-24001500-W SW38-12503000-W
 SW38-12603000-W SW38-19002000-W
 SW42-12003500-W 이번기재
적용기준: K 60950-1(2.0)(2011-12)
 (Standard)

「전기용품안전 관리법 시행규칙」 제6조제2항에 따라 위의 전기용품에 대하여 안전인증서를 발급합니다.
 We issue this Electrical Appliances Safety Certificate for the above electrical appliance in accordance with the Article 6(2) of the Enforcement Rule of the Electrical Appliances Safety Control Act.



2014 년 10 월 27 일
 (Year) (Month) (Day)

한국기계전기전자시험연구원장
 Korea Testing Certification



※ 이 인증서는 「전기용품안전 관리법」 에 따른 전기용품 안전성 확인에 한정된 것이며, 그 밖의 다른 법률이 적용되는 제품의 경우에는 해당 법률에 따라 추가로 인증·허가 등을 받아야 합니다.

- 첨부서류 1. 안전관리부품 및 재질목록 (List of Critical Components)
 2. 기본모델·파생모델의 내용 (Descriptions of the basic and series model)
 3. 전기용품 안전인증의 변경 현황 (Revisions Status)



Customer:

Switching Mode Power Supply

Model: [SW60-12005000-W](#)

SPECIFICATION NO.:

PRODUCT SPECIFICATIONS

Part no.: [SW60-12005000-WE5](#)



SW42-13003000-W
SW42-14003000-W
SW42-16802500-W
SW45-12603500-W
SW45-22002000-W
SW48-13003500-W
SW48-19502500-W
SW48-23002000-W
SW50-12504000-W
SW50-13503500-W
SW50-16803000-W
SW60-12005000-W
SW60-12504800-W
SW60-13004610-W
SW60-13504440-W
SW60-14404000-W
SW60-15003500-W
SW60-15503870-W
SW60-16503630-W
SW60-17003520-W
SW60-18003000-W
SW60-18503240-W
SW60-19003150-W
SW60-19503070-W
SW60-20502930-W
SW60-21502500-W
SW60-22002500-W
SW60-22502660-W
SW60-23002600-W

SW42-13503000-W
SW42-15002500-W
SW42-23001500-W
SW45-15003000-W
SW48-12004000-W
SW48-14403000-W
SW48-21502000-W
SW48-24002000-W
SW50-12604000-W
SW50-14403500-W
SW50-19002500-W
SW60-12504500-W
SW60-13004000-W
SW60-13504000-W
SW60-14004280-W
SW60-14504130-W
SW60-15004000-W
SW60-16003750-W
SW60-16803500-W
SW60-17503420-W
SW60-18003330-W
SW60-19003000-W
SW60-19503000-W
SW60-20003000-W
SW60-21002850-W
SW60-21502790-W
SW60-22002720-W
SW60-23002500-W
SW60-23502550-W

Customer:
Model: SW60-12005000-W
SPECIFICATION NO.:
Part no.: SW60-12005000-WE5

Switching Mode Power Supply

PRODUCT SPECIFICATIONS

Zertifikat

Certificate



Zertifikat Nr. *Certificate No.*
S 50274572 Blatt *Page*
0004

Ihr Zeichen *Client Reference* Unser Zeichen *Our Reference* Längstens gültig bis *Latest expiration date*
174026812 05-YBW- 16058594 004 06.03.2019 (day/mo/yr)

Genehmigungsinhaber *License Holder*
Hongkong Power-Tek International
Co., Limited
Room 1708A1 Nan Fung Tower
173 Des Voeux Road C.
Hong Kong

Fertigungsstätte *Manufacturing Plant*
Shenzhen Top-Asia Electronics
Co., Ltd.
3F//B XinRui Logistics Park
HouRui Huang'Tian Bao'an
Shenzhen, Guangdong 518102
P.R. China

Prüfzeichen *Test Mark*



Geprüft nach *Tested acc. to*
EN 60950-1:2006+A11+A1+A12
ZEK 01.4-08/11.11

Zertifiziertes Produkt (Geräteidentifikation)
Certified Product (Product Identification)

Lizenzentgelte - Einheit
License Fee - Unit

Netzgerät *Switching Adapter*

wie Blatt (as page) 01

Änderung
(Change)

Bezeichnung : SWpp-xy-W
(Type Designation)

ANLAGE (Appendix): 1.1

Dem Zertifikat liegt unsere Prüf- und Zertifizierungsordnung zugrunde,
Produkt und Fertigungsstätte erfüllen § 20 und § 21 des
Produktsicherheitsgesetzes.

*This certificate is based on our Testing and Certification Regulation.
Product and production fulfil par § 20 and § 21 of the
Product Safety Law.*

TÜV Rheinland LGA Products GmbH - Tillystraße 2 - 90431 Nürnberg
Tel.: (+49/221)8 06 - 13 71 e-mail: cert-validity@de.tuv.com
Fax: (+49/221)8 06 - 39 35 http://www.tuv.com/safety

Ausstellungsdatum *Date of Issue* : 20.10.2014 (day/mo/yr)



Zertifizierungsstelle

Dipl.-Ing. (HSt) C. Rüter

Customer:
Model: SW60-12005000-W
SPECIFICATION NO.:
Part no.: SW60-12005000-WE5

Switching Mode Power Supply

PRODUCT SPECIFICATIONS

C E R T I F I C A T E



of Conformity
Low Voltage Directive 2006/95/EC

Registration No.: AN 50294861 0001

Report No.: 16058594 004

Holder: Hongkong Power-Tek International
Co., Limited
Room 1708A1 Nan Fung Tower
173 Des Voeux Road C.
Hong Kong

Product: Power Supply
Switching Adapter

Identification: Series Type Designation: SWpp-xy-W
For a detailed listing of the variables x, y refer to
license S 50274572 0001-0004.
Serial No.: n.a.
(Issued in conjunction with above TÜV Rheinland license.)

This certificate of conformity is based on an evaluation of a sample of the above mentioned product. Technical Report and documentation are at the Licence Holder's disposal. This is to certify that the tested sample is in conformity with all revision of Annex I of Council Directive 2006/95/EC, in its latest amended version, referred to as the Low Voltage Directive. This certificate does not imply assessment of the series-production of the product and does not permit the use of a TÜV Rheinland mark of conformity. The holder of the certificate is authorized to use this certificate in connection with the EC declaration of conformity according to Annex III of the Directive.

Certification Body



Date 21.10.2014

Dipl.-Ing. (HS1) C. Rüther

TÜV Rheinland LGA Products GmbH - Tillystraße 2 - 90431 Nürnberg

CE The CE marking may be used if all relevant and effective EC Directives are complied with. CE

Customer:
Model: SW60-12005000-W
SPECIFICATION NO.:
Part no.: SW60-12005000-WE5

Switching Mode Power Supply

PRODUCT SPECIFICATIONS

Industrial Services, Mobility and Transport,
Product Safety and Quality, Education and
Consulting, IT Services and Innovation



Hongkong Power-Tek International
Co., Limited
Mr. Daol Wong
President
Room 1708A1 Nan Fung Tower
173 Des Voeux Road C.
Hong Kong

Date : 21.10.2014
Our ref. : YBW 05
Your ref. : 174026812

Ref : S GS-Mark Approval

Type of Equipment : Switching Adapter
Model Designation : See Certificate
Certificate No. : S 50274572 0004
Report No. : 16058594 004

Dear Mr. Daol Wong,

The above specified equipment has been tested and found to be in accordance with the relevant requirements.

Please find enclosed your certificate as specified above.

If cancellation of the certificate is submitted by 15 November in a given year, no fee will be charged for the following year.

The certificate is issued with the reservation that the license holder applies all information required in § 6 of the ProdSG related to name and address of the manufacturer or his authorized representative / importer, including their respective contact addresses on the product prior to marketing of the product in the European Economic Area.

With kind regards,

Certification Body

Dipl.-Ing. (HS1) C. Ruether

Enclosure

TÜV RHEINLAND TAIWAN LTD.

11F., No. 708, Sec. 4, Bade Rd.,
Songshan Dist., Taipei City 106,
Taiwan R. O. C.
Tel. (02) 2172-7000
Fax (02) 2528-0018
<http://www.tuv.com>

TAICHUNG BRANCH:

No. 5, Lane 58, Sec. 3, Minsheng Rd.,
Daye Dist., Taichung City 428
Taiwan, R. O. C.
Tel. (04) 2560-2998
Fax (04) 2560-3588

Customer:
Model: SW60-12005000-W
SPECIFICATION NO.:
Part no.: SW60-12005000-WE5

Switching Mode Power Supply

PRODUCT SPECIFICATIONS

Industrial Services, Mobility and Transport,
Product Safety and Quality, Education and
Consulting, IT Services and Innovation



Hongkong Power-Tek International
Co., Limited
Mr. Daol Wong
President
Room 1708A1 Nan Fung Tower
173 Des Voeux Road C.
Hong Kong

Date : 21.10.2014
Our ref. : YBW 05
Your ref. : 174026812

Ref : AN Certificate of Conf. Low Voltage D.

Type of Equipment : Switching Adapter
Model Designation : See Certificate
Certificate No. : AN 50294861 0001
Report No. : 16058594 004

Dear Mr. Daol Wong,

We herewith confirm that a sample of the above mentioned technical equipment has been tested and was found to be in accordance with the relevant requirements.

Enclosed please find your Certificate of Conformity.

We appreciate your kind support and would like to offer our assistance and continuous services in the future.

With kind regards,

Certification Body

Dipl.-Ing. (HS1) C. Ruether

Enclosure

TÜV RHEINLAND TAIWAN LTD.

11F., No. 758, Sec. 4, Bada Rd.,
Songshan Dist., Taipei City 105,
Taiwan R. O. C.
Tel. (02) 2172-7000
Fax (02) 2528-0018
<http://www.tuv.com>

TAICHUNG BRANCH:

No. 8, Lane 35, Sec. 3, Minsheng Rd.,
Daya Dist., Taichung City 428
Taiwan, R. O. C.
Tel. (04) 2500-2998
Fax (04) 2500-3098

Customer:
Model: SW60-12005000-W
SPECIFICATION NO.:
Part no.: SW60-12005000-WE5

Switching Mode Power Supply

PRODUCT SPECIFICATIONS

QQGQ7.E333054 - Power Supplies, Information Technology Equipment Including El... Page 1 of 1



ONLINE CERTIFICATIONS DIRECTORY

QQGQ7.E333054

Power Supplies, Information Technology Equipment Including Electrical Business
Equipment Certified for Canada

[Page Bottom](#)

Power Supplies, Information Technology Equipment Including Electrical Business
Equipment Certified for Canada

[See General Information for Power Supplies, Information Technology Equipment Including Electrical Business Equipment Certified for Canada](#)

HONGKONG POWER-TEK INTERNATIONAL CO LTD
ROOM 1708, A1
NAN FUNG TOWER
173 DES VOEUX RD C
CENTRAL, HONG KONG

E333054

AC Adapter, Model(s) SWpp-xxxxyyyy-W(A1)

ADAPTER, Model(s) SWPP-xxxxyyyy-US ('xxxx' is 4 digit number which represents the output voltage in Volt dividing by 100 form 0420 to 2400, for example 0420 represents the output voltage is 4.2V, 2400 represents the output voltage is 24V; 'yyyy' is 4 digit number which represents the output current in ampere dividing by 1000 in step of 0.001A from 0500 to 2500, for example, 0500 represents the output current is 0.5A, 2500 represents the output current is 2.5A; maximum output wattage is 15W.)

A1 - pp can be 24 to 60 xxxx can be 1200 to 2400 in step of 50, when xxxx = 1200, yyyy can be 1000 to 5000, when xxxx = 1250, yyyy can be 1000 to 4800, when xxxx = 1300, yyyy can be 1000 to 4620, when xxxx = 1350, yyyy can be 1000 to 4440, when xxxx = 1400, yyyy can be 1000 to 4290, when xxxx = 1450, yyyy can be 1000 to 4140, when xxxx = 1500, yyyy can be 1000 to 4000, when xxxx = 1550, yyyy can be 1000 to 3870, when xxxx = 1600, yyyy can be 1000 to 3750, when xxxx = 1650, yyyy can be 1000 to 3640, when xxxx = 1700, yyyy can be 1000 to 3530, when xxxx = 1750, yyyy can be 1000 to 3430, when xxxx = 1800, yyyy can be 1000 to 3330, when xxxx = 1850, yyyy can be 1000 to 3240, when xxxx = 1900, yyyy can be 1000 to 3160, when xxxx = 1950, yyyy can be 1000 to 3080, when xxxx = 2000, yyyy can be 1000 to 3000, when xxxx = 2050, yyyy can be 1000 to 2930, when xxxx = 2100, yyyy can be 1000 to 2860, when xxxx = 2150, yyyy can be 1000 to 2790, when xxxx = 2200, yyyy can be 1000 to 2730, when xxxx = 2250, yyyy can be 1000 to 2670, when xxxx = 2300, yyyy can be 1000 to 2610, when xxxx = 2350, yyyy can be 1000 to 2550, when xxxx = 2400, yyyy can be 1000 to 2500

[Last Updated](#) on 2011-10-20

[Questions?](#)

[Print this page](#)

[Notice of Recipient](#)

[Page Top](#)

2012 UL LLC

The appearance of a company's name or product in this database does not in itself assure that products so identified have been manufactured under UL's Follow-Up Service. Only those products bearing the UL Mark should be considered to be listed and covered under UL's Follow-Up Service. Always look for the Mark on the product.

UL permits the reproduction of the material contained in the Online Certification Directory subject to the following conditions: 1. The Guide Information, Designs and/or Listings (files) must be presented in their entirety and in a non-misleading manner, without any manipulation of the data (or drawings). 2. The statement "Reprinted from the Online Certifications Directory with permission from UL" must appear adjacent to the extracted material. In addition, the reprinted material must include a copyright notice in the following format: "© 2012 UL LLC".

<http://database.ul.com/cgi-bin/XYV/template/LISEXT/1FRAME/showpage.html?nam...> 2012-5-10

Customer:
Model: SW60-12005000-W
SPECIFICATION NO.:
Part no.: SW60-12005000-WE5

Switching Mode Power Supply

PRODUCT SPECIFICATIONS



Date of Issue: 2014/09/29
Attestation Number: DECE1409091

Product: AC/DC ADAPTER

Model No.: SWpp-xy-W ("pp" can be 24-60 for marketing purpose; "x" is 4 digit number which represents the output voltage, from 12.0V to 24.0V in step of 0.5V, for example, 1200 represents the output voltage is 12.0V, 2400 represents the output voltage is 24.0V; "y" is 4 digit number which represents the output current, from 1.0A to 5.0A in step of 0.1A, for example, 1000 represents the output current is 1.0A, 5000 represents the output current is 5.0A)

Applicant: HONGKONG POWER-TEK INTERNATIONAL CO. LIMITED.

Address: ROOM 1708A1 NAN FUNG TOWER, 173 DES VOEUX ROAD C., HONG KONG

And, in accordance to the following Applicable Directives

Applicable to EUROPEAN COUNCIL DIRECTIVE 2004/108/EC

(The Information Technology Equipment)

That this product has been assessed against the following Applicable Standards

EN 55022:2006 (Class B)	EN 55024 : 1998/ A1:2001/ A2:2003
EN 61000-3-2 : 2006	IEC 61000-4-2 : 1995/ A1:1998/ A2:2001
EN 61000-3-3 : 1995/ A1:2001/ A2:2005	IEC 61000-4-3 : 2006
	IEC 61000-4-4 : 2004
	IEC 61000-4-5 : 2005
	IEC 61000-4-6 : 2006
	IEC 61000-4-8 : 1993/A1: 2001
	IEC 61000-4-11 : 2004

CERDEX hereby acknowledges that:

The measurements shown in this test report may issue a DECLARATION of CONFORMITY and apply the CE mark in accordance to European Union Rules.

Attestation by: _____

Jeff Lee / Supervisor

2014/09/29

Date

Customer:
Model: SW60-12005000-W
SPECIFICATION NO.:
Part no.: SW60-12005000-WE5

Switching Mode Power Supply

PRODUCT SPECIFICATIONS



FCC VERIFICATION OF COMPLIANCE

Date of Issue: 2014/09/29
Attestation Number: DEFV1409091

Product: AC/DC ADAPTER

Model No.: SWpp-xy-W ("pp" can be 24-60 for marketing purpose; "x" is 4 digit number which represents the output voltage, from 12.0V to 24.0V in step of 0.5V, for example, 1200 represents the output voltage is 12.0V, 2400 represents the output voltage is 24.0V; "y" is 4 digit number which represents the output current, from 1.0A to 5.0A in step of 0.1A, for example, 1000 represents the output current is 1.0A, 5000 represents the output current is 5.0A)

Applicant: HONGKONG POWER-TEK INTERNATIONAL CO. LIMITED.

Address: ROOM 1708A1 NAN FUNG TOWER, 173 DES VOEUX ROAD C.,
HONG KONG

And, in accordance to the following Applicable Directives

Applicable to ANSI C63.4 – 2003

(The Information Technology Equipment)

That this product has been assessed against the following Applicable Standards

CISPR PUB. 22 and FCC Part 15 Subpart B Class B (Verification)

This Verification of Compliance is hereby issued to the above named company.
The test Results of this report relate only to the tested sample identified in this report.

Attestation by:  _____ 2014/09/29
Jeff Lee / Supervisor Date

