

Scanning	LIB.

# SPECIFICATION FOR APPROVAL

• CUSTOMER	:
• ITEM	: Power Supply Unit.
• DESCRIPTION	: LCD & LED Monitor Power Supply.
• CUSTOMER P/NO	:
• SUPPLIER P/NO	: BRK-4500
• DATE	: 2015-06-08

CUSTOMER	EN'GR	CHKD	APPD

SUPPLIER	EN'GR	CHKD	APPD
BAROMKOREA CO., LTD			

**MAKER : BAROMKOREA Co., Ltd.**



TEL : 82-2-801-0370

FAX : 82-2-801-0380

# DOCUMENTATION FOR APPROVAL

<b>Product</b>	<b>LCD &amp; LED Monitor Power Supply</b>
<b>Model Name</b>	<b>BRK - 4500</b>
<b>Customer P/No.</b>	

## CONTENTS

NO.	A table of contents	Page
1	Documentation of approval	2
2	Contents	3
3	Revision History	4
4	<u>Power Specification</u> 1. INTRODUCTION 1.1 Product Description 1.2 Parameter Specification 2. ELECTRICAL REQUIREMENTS 2.1 Input Requirements 2.2 Output Requirements 2.3 Power Output Protection 3. RELIABILITY 3.1 Environment Test 3.2 Mean Time Between Failure(MTBF) 3.3 Life/Power On Hours 3.4 Burn-in Test Condition 4. SAFETY & EMS 4.1 Earth Leakage current 4.2 Hi-Pot Test(Dielectric withstand voltage) 4.3 Insulation Resistance 4.4 Input AC Surge 4.5 Surge & Impulse Test 4.6 RFI / EMI Standards 4.7 Safety Standards 5. ENVIRONMENT REQUIREMENTS 5.1 Temperature 5.2 Humidity 6. POWER ON/OFF SIGNAL 6.1 LOW SIGNAL 6.2 HIGH SIGNAL 6.3 AUTO SIGNAL 6.4 Power on/off signal select 7. CONNECTOR PIN ASSIGNMENT & SPECIFICATION  8. POWER SUPPLY ASSEMBLY DIMENSION	5



# POWER SPECIFICATION

## 1. INTRODUCTION

### 1.1 Product Description

This specification defines the input, output, performance characteristics, environment, noise and safety requirements for a LCD & LED Monitor (TV) power supply.

### 1.2 Parameter Specification

Unless specification otherwise, all parameters must be met over the limit of temperature Load, and input voltage.

## 2. ELECTRICAL REQUIREMENTS

### 2.1 Input Requirements

#### 2.1.1 Input Voltages

- Normal Voltage: 100 ~ 240 Vrms
- Voltage Range : 85 ~ 264 Vrms

#### 2.1.2 Input Frequency

- Normal Frequency: 50 ~ 60Hz
- Frequency range : 47 ~ 63Hz

#### 2.1.3 Input Current

- under 6 Arms at 100Vac & Maximum Load

#### 2.1.4 Power Factor

- PF  $\geq$  0.9 at Maximum Load & 100Vac~240Vac condition.

#### 2.1.5 Configuration

- 3 Conductors (Live, Neutral, F.G)

#### 2.1.6 Input Fuse

- The live line side of the input shall have a fuse.

#### 2.1.7 Primary Over Current Protection

- An adequate internal fuse on the AC input line shall be provided.

#### 2.1.8 Inrush Current

- The inrush current of power supply shall be less than the rating of its critical components (including bulk rectifiers and surge limiting device) for all condition of line voltage of 2.1.1
- Cold start: under 60Ap-p at AC 100Vac ~ 240Vac

#### 2.1.9 Efficiency

- The power supply efficiency shall be more than 85% measure at the 220Vac maximum load as specified in paragraph 2.2.1 with the AC input set at the nominal voltage.

### 2.2 Output Requirements

#### 2.2.1 Maximum Output Voltage and Current

Output Name	Output Typical [V]	OUTPUT REGULATION LIMIT	Output Current(A)			Remark
			Min.	Typ.	Max. *1)	
+5VS	+5	4.75VDC ~ 5.25VDC	0	1.0	1.2	
+5VD	+5	4.75VDC ~ 5.25VDC	0.1	2.0	2.4	
+12V	+12	11.4VDC ~ 12.6VDC	0.2	7.0	8.0	Total Maximum Power 432W
+24V	+24	22.8VDC ~25.2VDC	1.0	15.0	16.5	

\*1) This power supply is a 60-minute period, the maximum current that can be used for about 10-minutes with a maximum current.

### 2.2.2 Ripple and Noise

Ripple and noise are defined as periodic or random signal over frequency band of 10Hz to 20MHz. Measurements shall be made with an oscilloscope with 20MHz bandwidth.

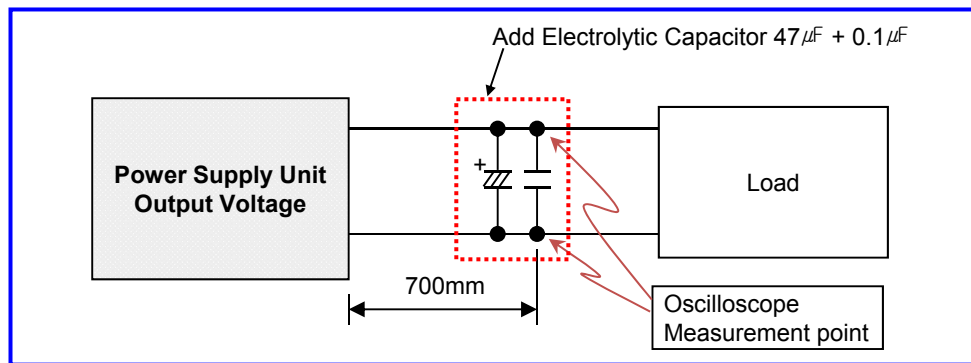

Output Voltage	5VS	5VD	12V	24V
Ripple Voltage Range (mVp-p)	150mV	150mv	240mV	480mV

※ Ripple & noise are measured at 20MHz of bandwidth by using a 12" twisted pair-wire terminated with a 0.1uF & 47uF parallel capacitor.

#### ☞ Test condition

- Temperature: 25°C room temperature
- Test equipment: Resistance load

### 2.2.3 Overshoot

The output overshoot at turn –on shall not exceed 20% of normal voltage value with or without the load connected.

### 2.2.4 Hold up Time

The power supply shall maintain voltage regulation within the specified limits in paragraph 2.2.1 for at least 10ms after lost of input voltage measure at 220Vac and at maximum output load.

### 2.2.5 Output Rise Time

At turn on the rise time of output voltage shall be less than 2000msec.

※ Measured from the 10% point to the 90% point of the normal

#### ☞ Test condition

- Temperature: 25°C room temperature
- Test equipment: Resistance load

### 2.2.6 Power Saving Management [PS - ON = OFF Mode]

Output Voltage	5VS	5VD	12V	24V
Load [A]	30mA	-		
Wattage [W]	≤ 0.5W [at 230Vac / 50Hz]			

## 2.3 Power Output Protection

### 2.3.1 Over Current Protection(OCP)

The power supply shall not be damaged by a over current from the output to return Line.

Protection to be invoked if current exceed maximum rating about 10% or more.

The other lines shall be in maximum load condition

### 2.3.2 Over Voltage Protection(OVP)

The voltage will not exceed the upper trip limit.

Noise spikes that exceed the lower trip limit for less than 10μs will not clamp the output voltage to zero.

### 2.3.3 Short Circuit Protection(SCP)

An output short circuit is defined as output impedance of less than 0.1 ohms.

The power supply shall not be damaged by short between DC output and DC ground.

### 2.3.4 Specification of Protection operating

NO	Output Voltage Name	*1) Over Current Protection		Over Voltage Protection		Short circuit Protection
		Range[A]	Protection	Range[V]	Protection	
1	5VS	1.5A more	Auto Recovery Or Shut Down	5.6 ~ 8	Auto Recovery	Auto Recovery Or Shut Down
2	5VD	3.0A more	Auto Recovery Or Shut Down	5.6 ~ 8	Auto Recovery	Auto Recovery Or Shut Down
3	12V	7.5A more	Auto Recovery Or Shut Down	15 ~ 20	Auto Recovery	Auto Recovery Or Shut Down
4	24V	17A more	Auto Recovery Or Shut Down	30 ~ 37	Auto Recovery	Auto Recovery Or Shut Down

\*1 The O.C.P point is measured when other output load is a maximum.

No hardware failure and No fire, when the output voltage decrease to 10%(Voltage Drop)

## 3. RELIABILITY

### 3.1 Mean Time Between Failure(MTBF)

The power supply shall be designed and produced to have a mean time between failures (MTBF) Of 40,000 operating hours at 90% confidence – level while operating under the following condition.

- AC input voltage : 230Vac
- Duty cycle : 6hours ON, 2hours OFF
- Ambient Temp. :  $25 \pm 2^{\circ}\text{C}$
- Humidity : prevailing condition

### 3.2 Life/Power On Hours

The power supply must be designed to operate for 40,000 power on hours.  
About 5 years at an ambient temperature of  $25^{\circ}\text{C}$

### 3.3 Burn-in Test Condition

More than 1 hours at  $40^{\circ}\text{C} (\pm 5^{\circ}\text{C})$ , Normal input voltage.

AC on/off must be test 1 time after burn-in.

Output Voltage	5VS	5VD	12V	24V
Aging Load [A]	1	2.4	3	11

☞ Test condition

- Test equipment: Electronic load

## 4. SAFETY & EMS



### 4.1 Earth Leakage current

The power supply leakage current shall be less than 0.5mA

### 4.2 Hi-Pot Test (Dielectric withstand voltage)

- ① Primary to Secondary : 3.0KVac for 1 minute  
→ 3.6KVac for 3 seconds (mass production)
  - ② Primary to F.G : 1.5KVac for 1 minute  
→ 1.8KVac for 3 seconds (mass production)
- ※ Cut-off current : 10mA

### 4.3 Insulation Resistance

Insulation resistance shall be  $8\text{M}\Omega$  or more at 500Vdc between primary Live, Neutral line and secondary.



#### 4.4 Input AC Surge

The power supply withstand 300Vrms input for 10 seconds.

#### 4.5 Surge & Impulse Test

- ① Lightning Surge :  $\pm 4\text{kV}$ (L1 ~ L2) 3 time,  $\pm 4\text{kV}$ (L1 ~ FG, L2 ~ FG) 3 times
- ② Impulse Noise Test : 2kV, Normal/Common mode, Polarity(+,-) / Phase( $0^\circ \sim 360^\circ$ )

#### 4.6 RFI / EMI Standards

The power supply shall comply with a following RFI/EMI standards when tested in a system configuration.

- CISPR, class B

The limits shall be met with a margin of at least more than 5dB at all applicable frequencies.

#### 4.7 Safety Standards

The Power Supply Unit shall be tested with the following safety standards.

- UL60950, UL6500

- IEC60950, IEC60065

- EN60950, EN60065

### 5. ENVIRONMENT REQUIREMENTS

#### 5.1 Temperature

- Operating Temp. :  $0 \sim 55^\circ\text{C}$  ( Without Case )

- Storage Temp. :  $-20 \sim 85^\circ\text{C}$  ( Without Case )

#### 5.2 Humidity

- Operation humidity : 30 ~ 85% non-condensing

- Storage humidity : 5 ~ 90% non-condensing

### 6. POWER ON/OFF SIGNAL

#### 6.1 LOW Signal

- Power On Level : 0V ~ 0.5V

- Power Off Level : 2.5V ~ 5V

#### 6.2 HIGH Signal

- Power On Level : 2.5V ~ 5V

- Power Off Level : 0V ~ 0.5V

#### 6.3 AUTO Signal

- Power On Level : Pin open (Always On Mode)

- Power Off Level : Mode does not exist

#### 6.4 ACD (AC Detect) Output Signal

- High logic more than 2.5V

- Low logic less than 0.7V

#### 6.5 Power on/off signal select

- Depends on the switch on the PCB components L/N. SW 450

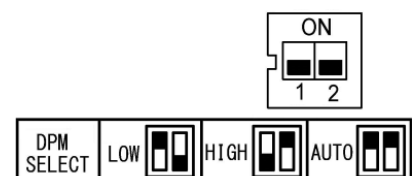
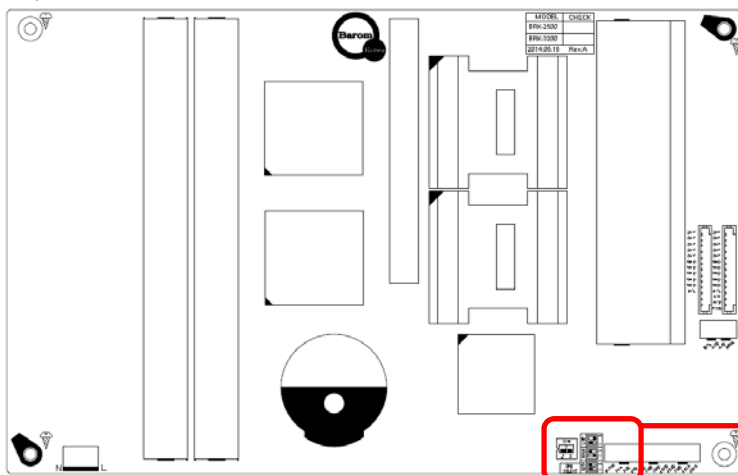

7. CONNECTOR PIN ASSIGNMENT & SPECIFICATION

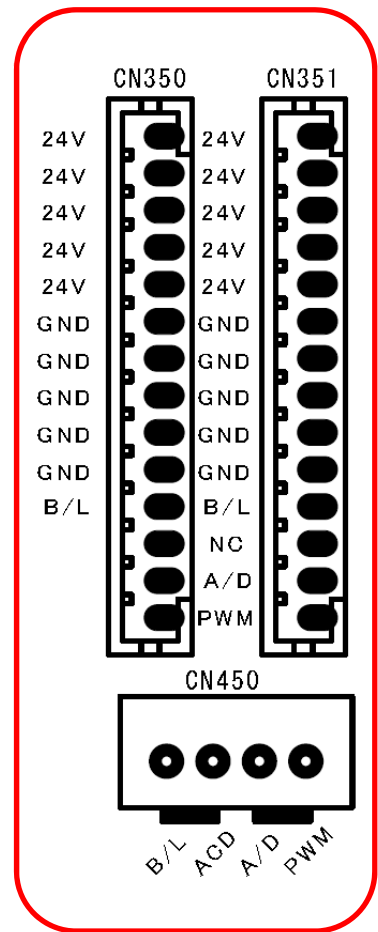
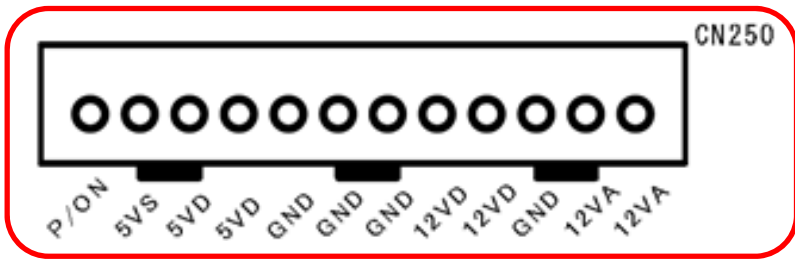
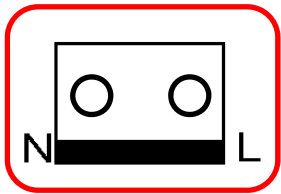
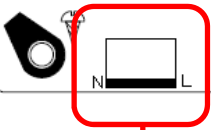
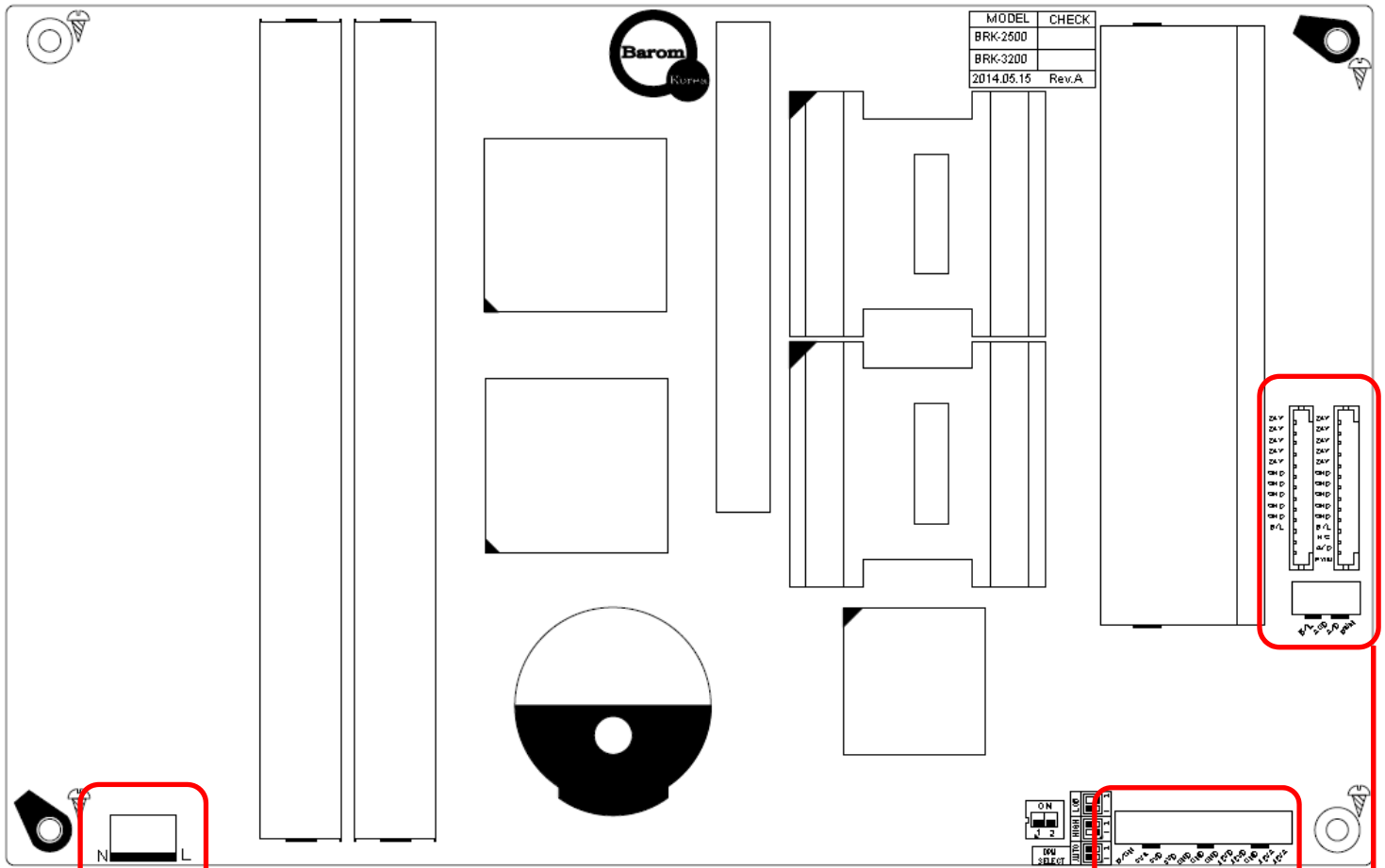

No.	Location No.	PART-NO.	VENDOR
1	CN100	YW396-03AV	YEONHO
2	CN250	SMW250-12	YEONHO
3	CN350	20010WS-14	YEONHO
4	CN351	20010WS-14	YEONHO
5	CN450	SMW250-04	YEONHO

**8. PSU ASSEMBLY DIMENSION**

- Size : 271(W) × 158(L) Height : MAX. 25mm(From the top of P.C.B)
- Weight : 920g max

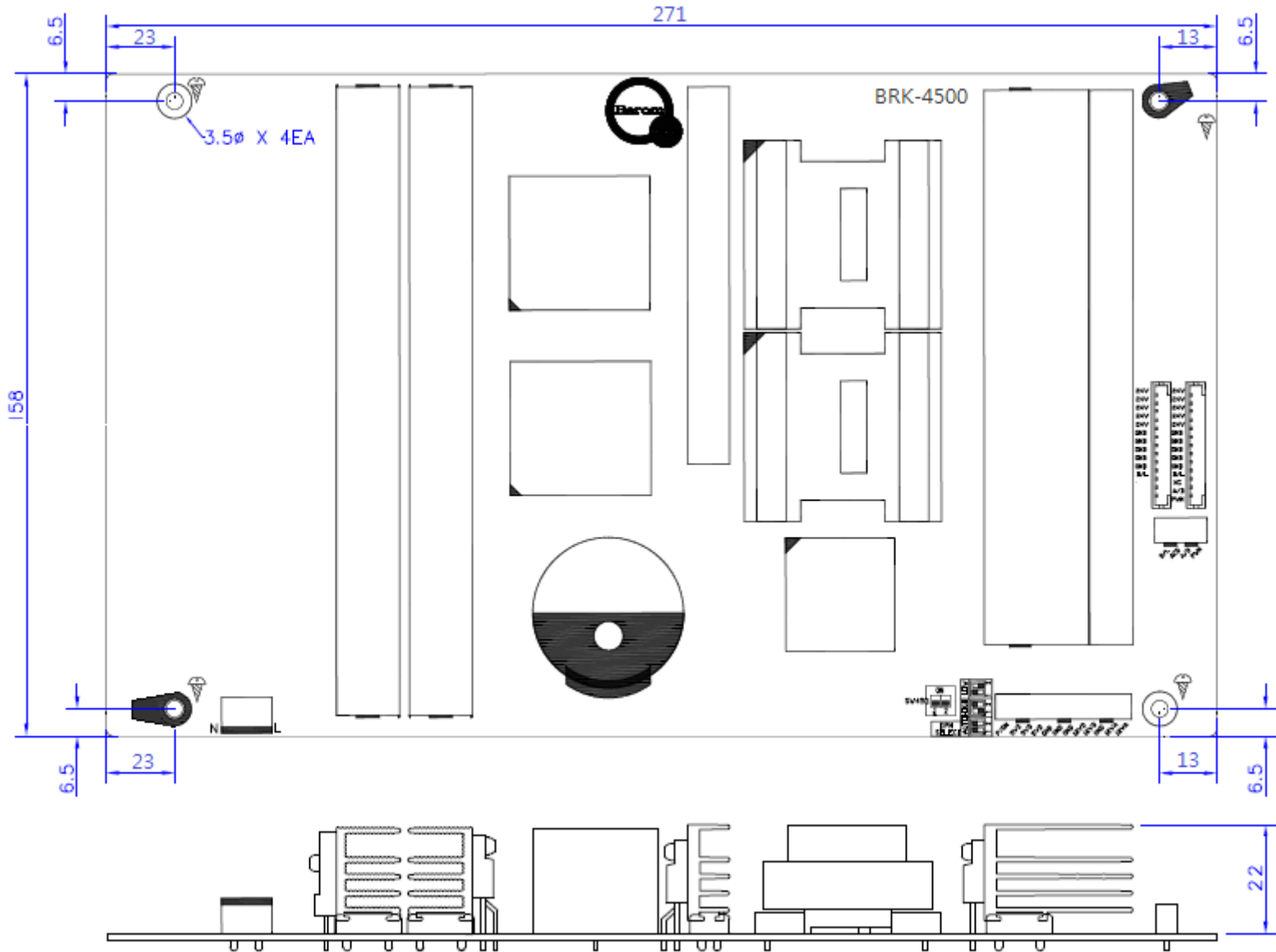

# POWER BAR-CODE LABEL DRAWING

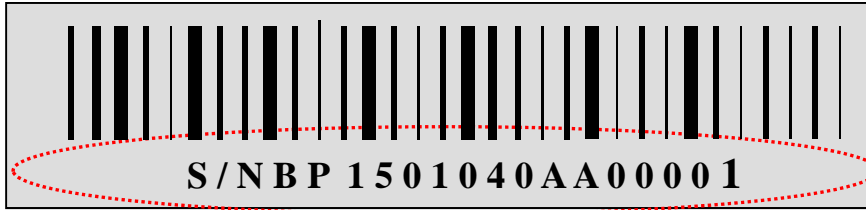

**S / N : B P 1 5 0 1 0 4 0 A A 0 0 0 0 1**

