

## SMKs – S type Sensor

### Smoke Sensor

– for the detection of Hydro Carbon, Smoke, Tobacco, Organic Solvent



S-type Sensor



T-type Sensor

Study

H2.5 W5.0 D4.0 SMT



U-type Sensor



<Package>



<OP Module>



<RL Module>

## 1. Sensitivity characteristic slope

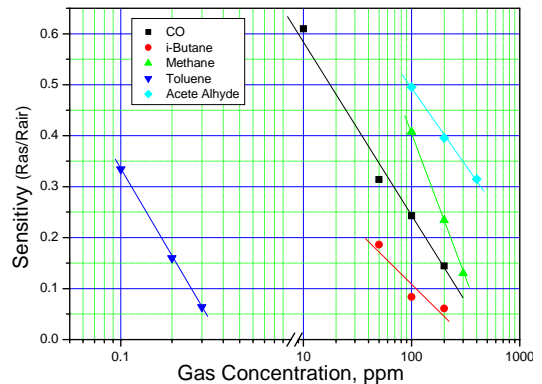
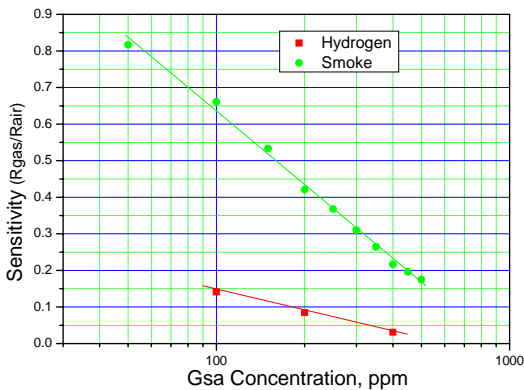

## 2. Basic Measuring Circuit & Stability

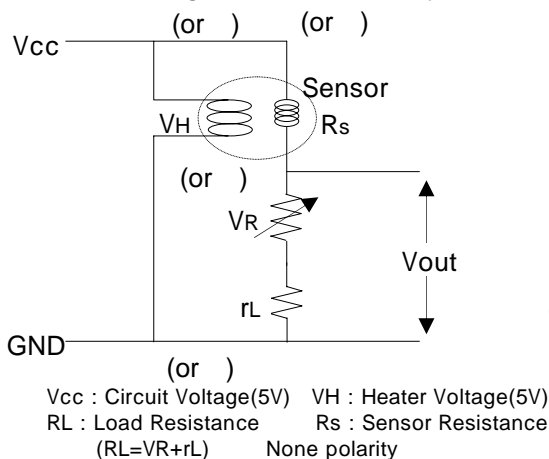

## Long Term Stability

- Room condition & temperature

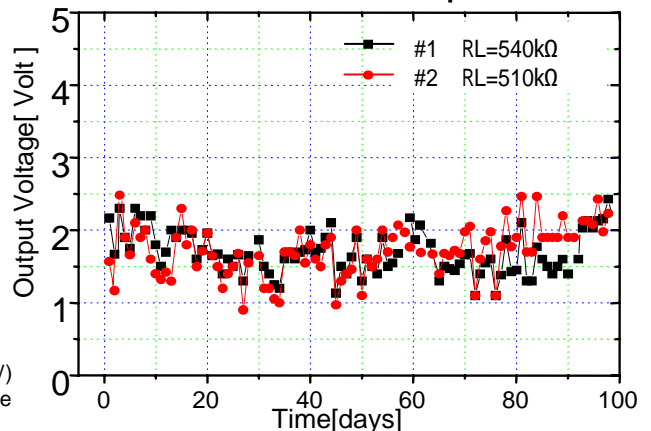

## 3. Specifications

### 3.1 Package (GSAT11), MOQ : None



#### a. Characteristics

Index		Spec. & Test condition				
Circuit Voltage	Vc	Sensor input Voltage : 1 ~ 12Volt, Sensor Resistance : refer to Rank table				
	VH	Heater input voltage : 5volt ± 1%, Heater Resistance : 19.0 ± 2.0				
	PH	Power consumption : Less than 650mW, Inrush current : Less than 300mA				
Characteristics of sensitivity ( ) (Rs,gas / Rs,air)	Gases	Methane	Alcohol	*TMA	Toluene	Acetaldehyde
	Concentration	100ppm	50ppm	0.1ppm	15ppm	100ppm
	Sensitivity	0.5	0.3	0.3	0.3	0.5
Guarantee	- 3years - Calibration interval 1years recommended					
Operating environment	- Temp. : -10 ~ 50 , Humidity : 5 ~ 90%RH, Non-condensing - Storage → Temp. : -10 ~ 70 , Humidity : 0 ~ 90%RH					
Reaction time(T90)	- Reaction Time(T90) : Less then 10sec - Recovering Time(T90) : Less then 30sec					

\* TMA : Tri-Methylamine \* Rs,gas : Output Resistance after gas injection.  
Rs,air : Output resistance in clean air.

#### b. Sensitivity error : ± 15% (Before compensation of temp. & humidity)

Ref. → RL : 100kΩ, Sensor resistance : 400kΩ  
Vout,air : 1.0volt (Input voltage : 5volt)

\* Tobacco (THE This 1.0) : smoke of 1peice  
→ amount 80ppm per 8m<sup>3</sup>

Hydrogen		140129	
Con.	Sensitivity	Con.	Sensitivity
0	1.000	300	0.071
20	0.512	320	0.061
40	0.399	340	0.051
60	0.333	360	0.041
80	0.286	380	0.033
100	0.250	400	0.024
120	0.220	420	0.016
140	0.195	440	0.009
160	0.173	460	0.001
180	0.154		
200	0.137		
220	0.122		
240	0.107		
260	0.094		
280	0.082		

(Sensitivity) = 1.000 - 0.375 × Log<sub>10</sub>(ppm)

Tobacco		140129	
Con.	Sensitivity	Con.	Sensitivity
0	1.0000	600	0.2715
40	0.7806	640	0.2593
80	0.6503	680	0.2479
120	0.5741	720	0.2372
160	0.5200	760	0.2270
200	0.4780	800	0.2174
240	0.4438	840	0.2082
280	0.4148	880	0.1995
320	0.3897	920	0.1911
360	0.3675	960	0.1831
400	0.3477	1000	0.1754
440	0.3298	1040	0.1680
480	0.3134	1080	0.1609
520	0.2984	1120	0.1541
560	0.2844	1160	0.1475

(Sensitivity) = 1.474 - 0.433 × Log<sub>10</sub>(ppm)

#### c. Sensor connection

Refer to basic measuring circuit

- Heater( DC 5volt  $\pm$  3% )  $\rightarrow$  : Vcc : GND, None polarity
- Sensor( DC/AC 0 ~ 12volt )  $\rightarrow$  : Vcc : GND, None polarity

#### d. Shipment

GSAS61-G

G : Classify Resistance rank ex) G11 -> Sensor Ra.(Rs,air) : 146 ~ 219k $\Omega$

- Sensor Resistance Table (Only package)

Rank Table No.:G

Rank	RL(k $\Omega$ )	Rs(k $\Omega$ )	Rank	RL(k $\Omega$ )	Rs(k $\Omega$ )	Rank	RL(k $\Omega$ )	Rs(k $\Omega$ )
G03	1.69	5.59~8.44	G07	8.66	28.5~42.9	G11	44.2	146~219
G04	2.55	8.44~12.6	G08	13.0	42.9~64.4	G12	66.5	219~329
G05	3.83	12.6~19.0	G09	19.6	64.4~97.1	G13	100	329~495
G06	5.76	19.0~28.5	G10	29.4	97.1~146	G14	150	495~743

- Basic Circuit RL Vout = 1.0Volt $\pm$ 0.2Volt  
RL=VR+rL (VR $\rightarrow$ RL\*2, rL $\rightarrow$ RL\*0.4)

#### e. Structure and Dimensions

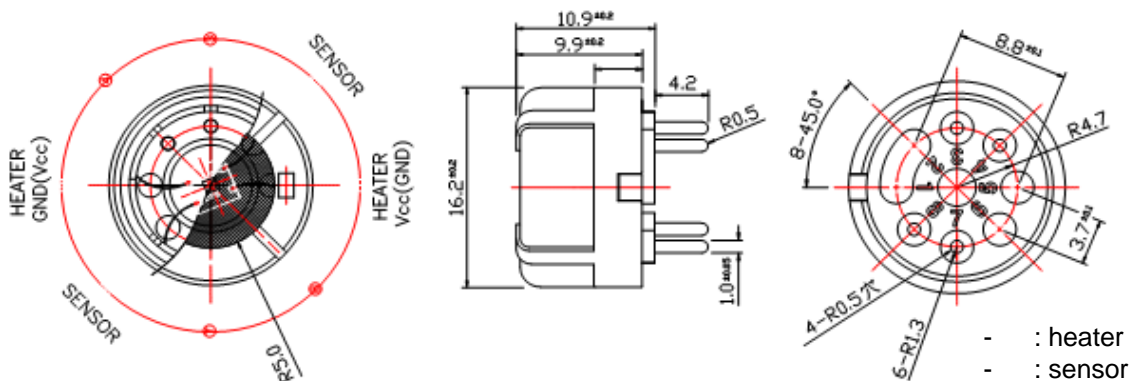

#### f. Caution

- Avoid of flux.
- At time soldering, ensure gap of more than 2.0mm form side PCB bottom.



### 3.2 OP Module (GSAS61-P1xx), MOQ : None

#### a. Characteristics

Index		Spec. & Test condition
Circuit Voltage	Vc	Module input Voltage : 5±0.1Volt
	PH	Power consumption : 680mW , Inrush current : Less than 310mA
Guarantee		- 2years over - Calibration interval 1years recommended
Worm up Time (T90)		- Less then 300sec
Reaction time(T90)		- Reaction Time(T90) : Less then 5sec - Recovering Time(T90) : Less then 30sec

#### b. Data sheet of gas concentration

- Output data : 0.5 ~ 5Volt
- Relay Output : less than 4.0Volt

- Error : ±7%

#### Hydrogen / Smoke

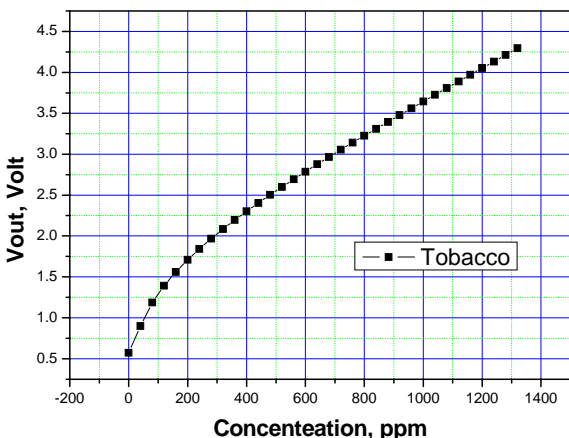
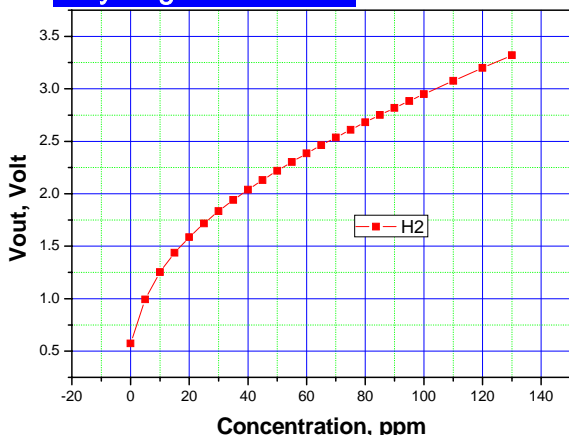

(Hydrogen) 140129				Smoke (Tobacco)140129			
(ppm)	(Volt)	(ppm)	(Volt)	(ppm)	(Volt)	(ppm)	(Volt)
0	0.57	60	3.50	0	0.57	480	2.50
5	1.81	65	3.59	40	0.64	520	2.60
10	2.14	70	3.67	80	1.19	560	2.69
15	2.37	75	3.76	120	1.39	600	2.79
20	2.56	80	3.84	160	1.56	640	2.88
25	2.72	85	3.91	200	1.71	680	2.97
30	2.86	90	3.99	240	1.84	720	3.05
35	2.98	95	4.06	280	1.97	760	3.14
<b>40</b>	<b>3.10</b>	100	4.13	320	2.08	800	3.23
45	3.21	110	4.27	360	2.20	840	3.31
50	3.31	120	4.40	400	2.30	880	3.39
55	3.41	130	4.53	440	2.40	920	3.48

$$H2 : (ppm) = 2.155 - 13.422 * (Vout) + 15.762 * (Vout)^2$$

- As occasion demands, pls calibration VR1 or VR3

VR1 : Reference value (in clean air)

VR2 : Gain (pls don't touch)

VR3 : Offset

#### c. Structure and Dimensions

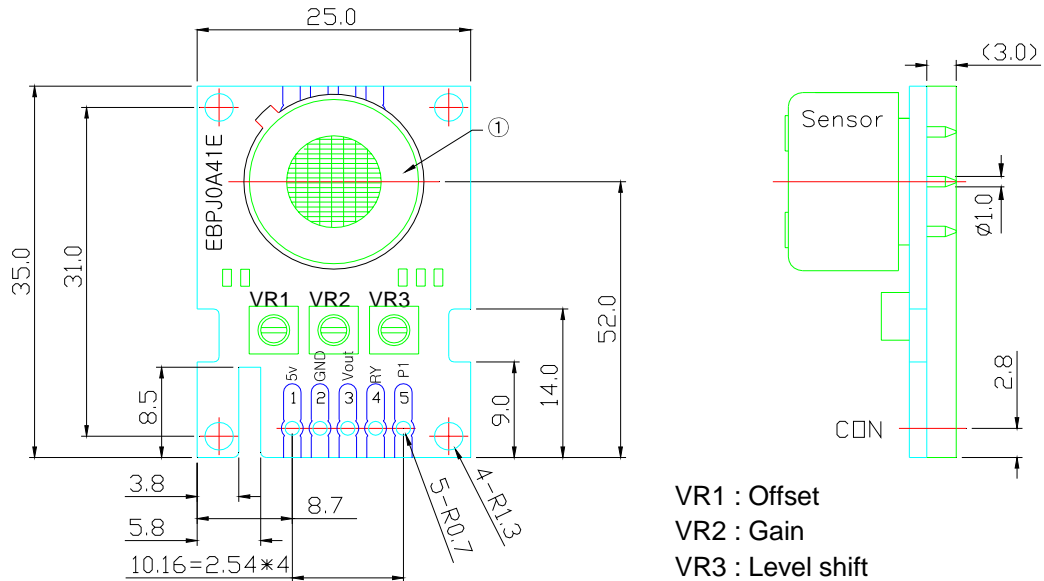

VR1 : Offset  
 VR2 : Gain  
 VR3 : Level shift

VR1 : Cal. In clean air  
 VR2 : Gain ( )  
 VR3 : Offset (Level shift)

#### d. Data output

Vcc : 5.0volt  
 GND  
 Data(Vout, analogue signal)  
 Relay

#### e. Relay Output

Hi(4.0~4.1volt) output at 40ppm(H<sub>2</sub>)  
 Hi(4.0~4.1volt) output at 700ppm(Smoke)

### 3.3 RL Module(GSAS61-P3xx), MOQ :More than 500pcs



#### a. Characteristics

Index		Spec. & Test condition
Circuit Voltage	Vc	Module input Voltage : $5 \pm 0.1$ Volt
	PH	Power consumption : Less than 660mW, Inrush current : Less than 31mA
Characteristics of Output data		Data
Guarantee		- 2years over - Calibration interval 1years recommended
Operating environment		- Temp. : -10 ~ 50 , Humidity : 5 ~ 90%RH, Non - condensing - Storage → Temp. : -20 ~70 , Humidity : 0 ~90%RH
Reaction time(T90)		- Reaction Time(T90) : Less then 10sec - Recovering Time(T90) : Less then 180sec

#### b. Output voltage

- Error :  $\pm 15\%$

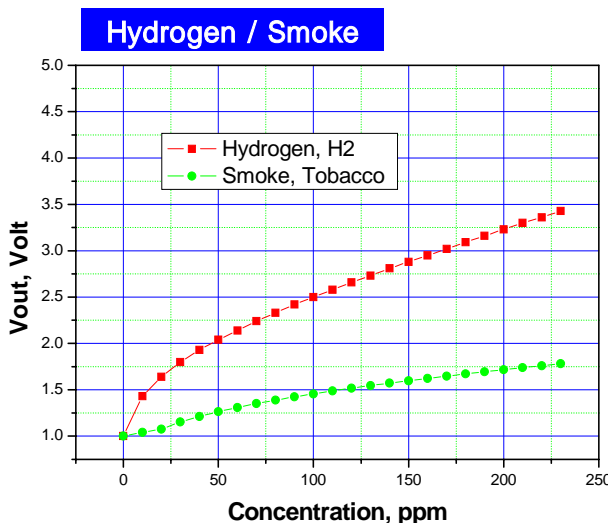

(Hydrogen) 140129				Smoke(Tobacco) 140129			
(ppm) (Volt)		(ppm) (Volt)		(ppm) (Volt)		(ppm) (Volt)	
0	1.00	120	2.66	0	1.00	240	1.82
10	1.43	130	2.73	20	1.03	260	1.86
20	1.64	140	2.81	40	1.18	280	1.91
30	1.80	150	2.88	60	1.28	300	1.95
40	1.93	160	2.95	80	1.37	340	2.03
50	2.04	170	3.02	100	1.44	380	2.11
60	2.14	180	3.09	120	1.51	420	2.19
70	2.24	190	3.16	140	1.57	460	2.26
80	2.33	200	3.23	160	1.62	500	2.33
90	2.42	210	3.30	180	1.67	540	2.40
100	2.50	220	3.36	200	1.72	580	2.47
110	2.58	230	3.43	220	1.77	620	2.54

Ref. → RL : 100kΩ, Sensor resistance : 400kΩ

Vout,air : 1.0volt (Input voltage 5volt)

$$* H2(ppm) = 5.369 - 41.277 * (Vout) + 31.486 * (Vout)^2$$

\* Tobacco (THE This 1.0) : smoke of 1peice  
→ amount 80ppm per 8m<sup>3</sup>

#### c. Sensor connection

#### d. Structure and Dimensions

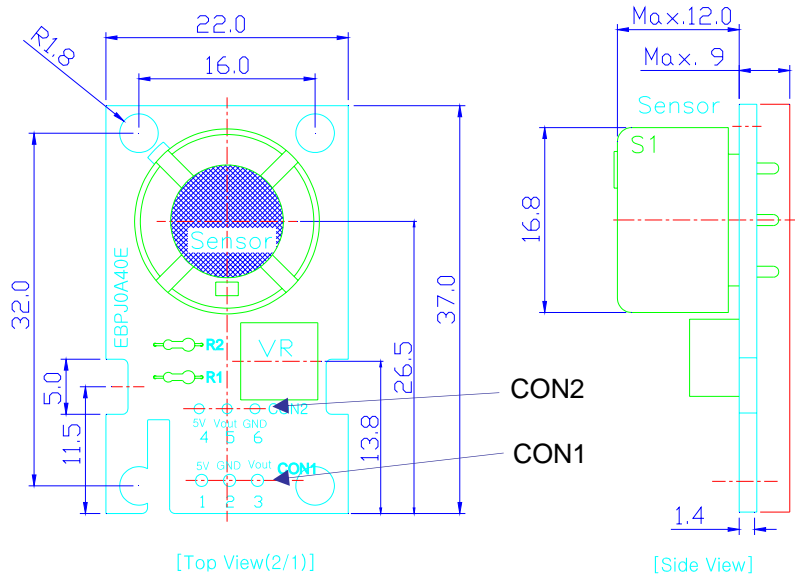

#### e. Data output (Caution CON1, CON2 land)

CON1                      Pitch : 2.54mm  
                                    R0.45 hole

CON2                      Pitch : 2.54mm  
                                    R0.45 hole

,	→ Vcc : 5.0volt
,	→ GND
,	→ Data(Vout, analogue signal)

#### 3.4 Circuit characteristics

Index	GSAS61	GSAS61 -P11X	GSAS61 -P21X <sup>study</sup>	GSAS61 -P3XX
Circuit Name	Package	OP -Module	MP -Module	RL -Module
Target Gas	HC, Smoke, Tobacco, Organic Solvent			
Accuracy	±15%	±7%	±7%	±10%
Measuring Circuit	Basic Circuit	Op -Amplifying	μ -Processor	Basic Circuit
Input Voltage	5Volt±3%	←	←	←
Output	0 ~ 4volt	0 ~ 4volt	Data : Digital Open collect	0 ~ 4volt
Worm -up time	-	Long	short	Long
MOQ	None	None	None	More than 500ea

#### 4. Comparison of products

Product code	Power Consumption	Warm-up time	Long term stability	Housing
<b>GSAT11</b> GSAT11 – PXXX	350mW	Long	Very Good	Plastic Package
<b>GSAS61</b> GSAS61 - PXXX	660mW	Short	Good	Small Metal Package

#### 5. Reaction time(T90)

Reaction Time(T90) : Less then 10sec  
[Between Rs,air\_b & Rs,gas]

Recovering Time(T90) : Less then 30sec  
[between Rs,gas & Rs,air\_a]

Beginning stability time(T90) : Less then 10 min

Rs,air\_b : Sensor Resistance without gases  
Rs,gas : Sensor Resistance after blowing gases  
Rs,air\_a : Sensor Resistance removing gases

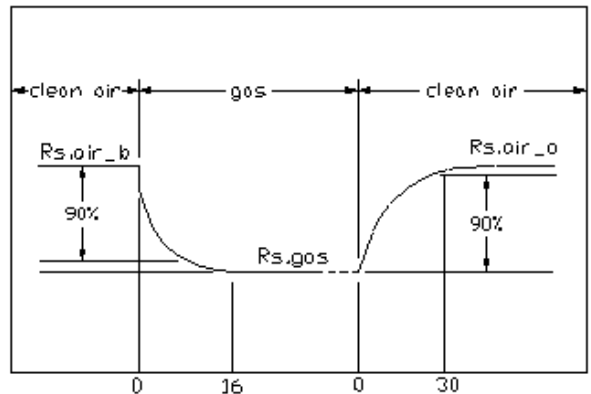

#### 6. Application

\* Hood, Ventilator, Damper, Gas Leak Alarm (Explosive gases)

#### 7. Product code

Sensor : **GSAS61**

(A) Division Circuit → **A** : Smoke(HC) Gas of Sensing gas

(S) Chip Size → **S** : 2.0mm \* 3.0mm

(1) Shape of Package → **6** : Plastic Cover

(1) Gas Sensing Characteristics

→ **1** : Normal

Module : **GSAS61 – P**

**1 2 3**

(1) Division Circuit → 1 : Op-amp circuit  
2 : Micro processor Circuit  
3 : Basic Circuit

(2) Sensing range → 0 : Parallel Ra.of sensor  
→ **1 : Standard**

(3) Connector → 0 : None  
→ 1 : SMAW250-03G

\*

#### summary